

Diesel Fuel Service Cart



Shown with optional flow meter

Table of Contents

Technical Specifications	3
5-Stage Filtration	4
System Overview.....	5
Hose Placement	6
Control Panel Operation	7
Diagnostic Signals	8
Filter Backflushing Instructions.....	9
Filter Element Replacement Instructions.....	10
Replacement Parts	11
Flow Meter Instructions	12
Flow Meter Instructions Continued	13
Flow Meter Instructions Continued.....	14
Flow Meter Instructions Continued	15
Troubleshooting	16

Reverso Pumps, Inc
201 SW 20th Street, Fort Lauderdale, FL 33315
Ph: (954) 522-0885 | Fax: (954) 522-0456

The information herein is the property of Reverso Pumps, Inc. Without written permission, any copying, transmitting to others, and other use except for which it is loaned is prohibited.

A filtration and dispensing system combined into a single portable unit. Removes sludge and separates water buildup caused by storing diesel fuel.

Basic Features

- Hose - 15 ft suction and discharge
- Separ Filter SWK-2000/40MK
- 30 micron paper element installed
- Electronic control box with 0 to 5 hour timer
- LED indicators for element replacement and backflushing
- Drip pan - easy to remove for cleaning
- Wired for 110V
- Vacuum gauge
- Safety shutdown and alarm for clogged filter and water
- Truck skids
- Hose hanger
- Strainer valve on suction side

Optional Features

- Manual nozzle
- Flow meter
- Variable length pickup/discharge tube
- Seal kit

Technical Specifications

Flow Rate	600 GPH / 2271 LPH	
Voltage	110V / 60 Hz, 220V / 50 Hz	
Port (suction)	Strainer Valve	
Amp. Draw	3.4A / 110V, 2A / 220V	
Pump Type	Vane	
Self-Priming	6.7 ft / 2m (wet gears)	
Hose Length	Suction	15 ft / 4.5m
	Discharge	15 ft / 4.5m
Dimensions	A	21.5" / 546 mm
	B	50.5" / 1,282 mm
	C	22.9" / 581 mm
Weight	105 lbs / 47.6 kg	

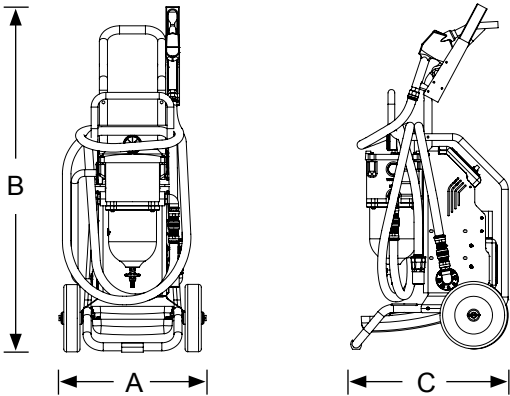

1

After entering the inlet(s), the 1st vane system spins the diesel fuel in a circular motion, generating centrifugal force.

2

In the bowl, fuel continues to spin – separating water and heavier particulates, through centrifugal force.

3

A 2nd vane system then forces the fuel to spin in a different direction – separating smaller water droplets and finer particulates.

4

A wider passage, just below the element, slows down fuel to allow more contaminants to settle into the bowl.

5

Finally, the element filters finer particulates out of the fuel before exiting through the outlet(s).

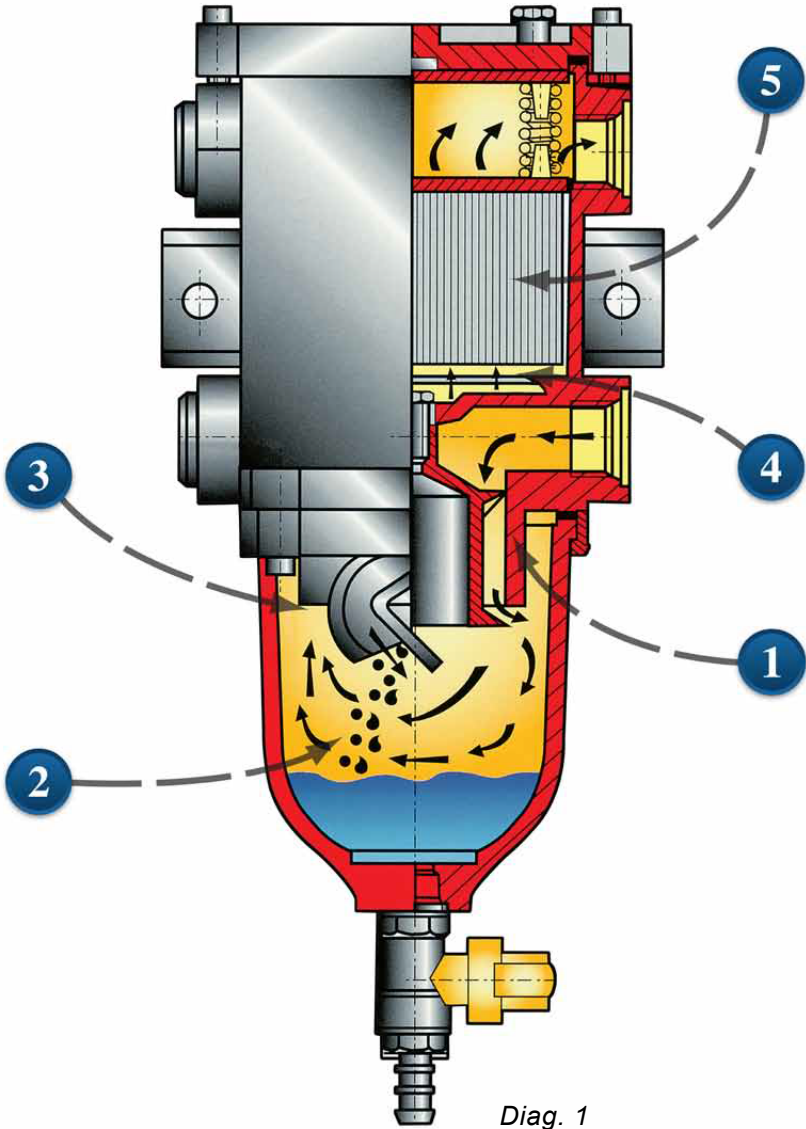

Diag. 1

System

1. Hose rack
2. Separ Filter SWK-2000/40UMK
3. Water contacts
4. Drain valve for Separ Filter SWK-200/40MK
5. Drip pan
6. Wheel
7. Discharge
8. Suction hose
9. Flow meter (optional)
10. Truck skids
11. Cart handle



Control Panel

1. Vacuum gauge
2. In use indicator light
3. Alarm indicator light
4. Start/stop button
5. Mechanical timer

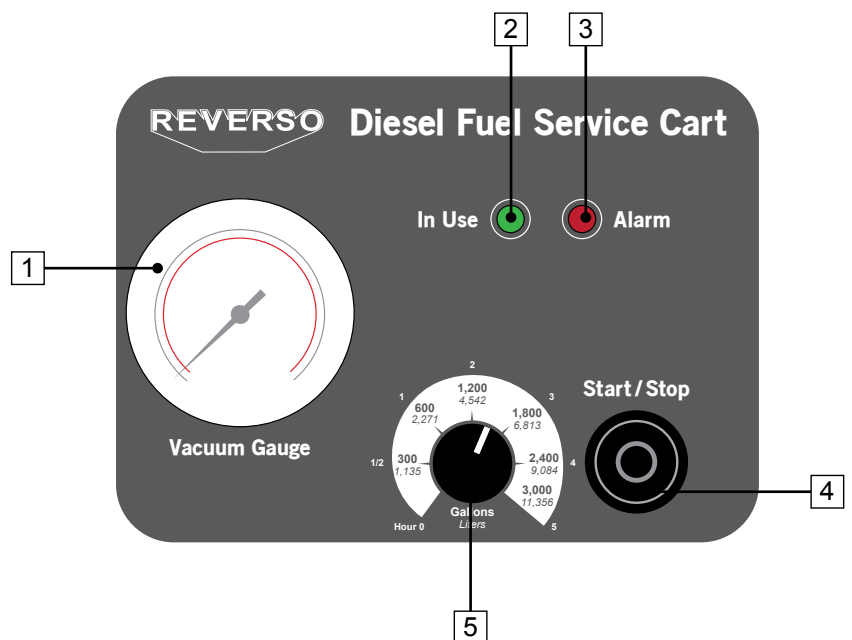

The system will filter diesel fuel while transferring or dispensing from one tank to another. In these scenarios, ensure the following points are addressed for proper operation.
For Diesel only.

Polish a Storage Tank

See Figure A

- The suction hose should originate near but not on the bottom of tank (or drum).



Figure A

Polish Engine Tank or When Dispensing

See Figure B and C.

- The suction hose should originate from the lowest point of tank (or drum).
- Place dispensing nozzle or hose into the tank that will receive the clean fuel.



Figure B



Figure C

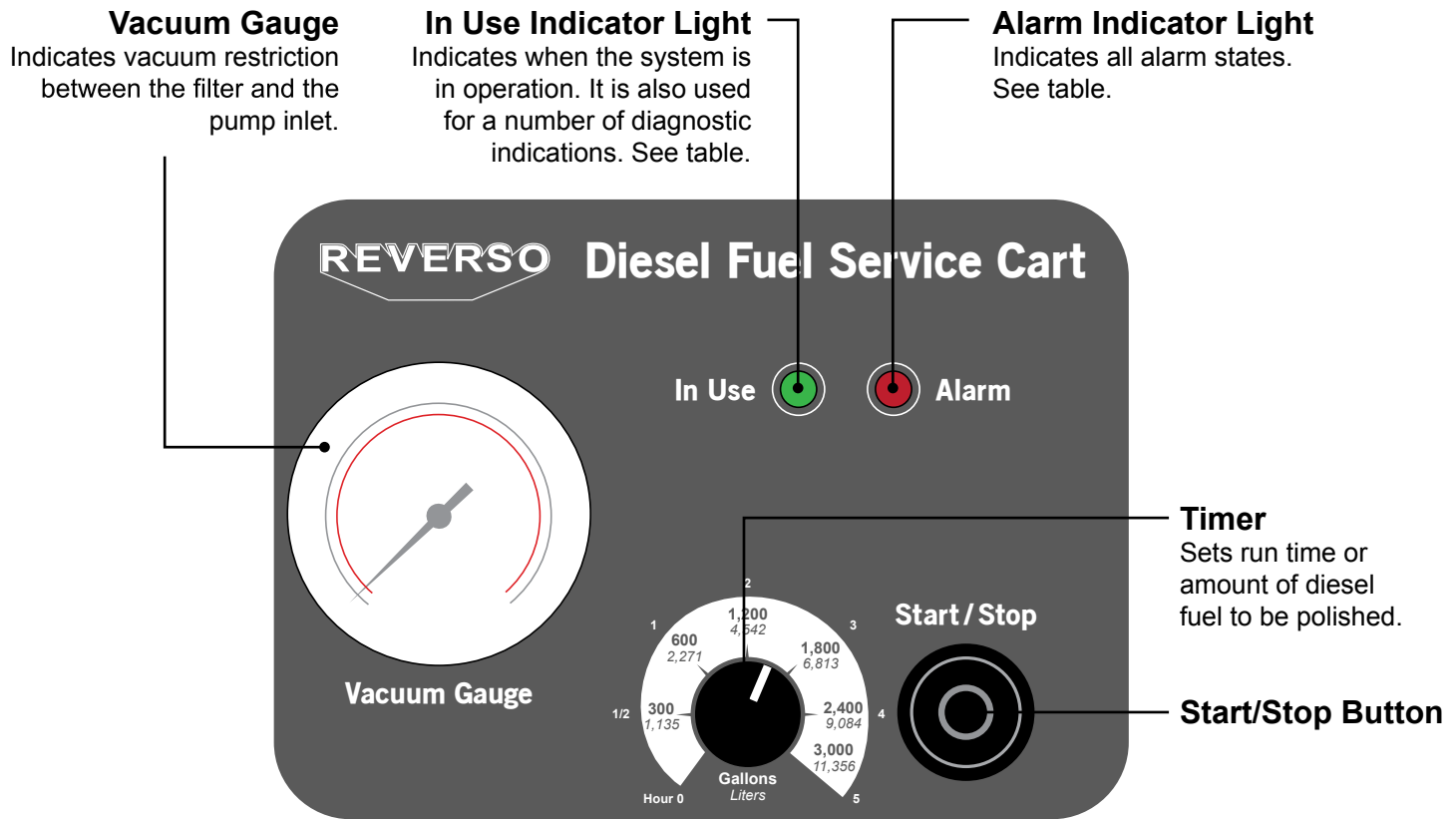

To Polish a Tank

1. Reset timer to clear memory left over from last run time. To do this, press start/stop button for about 2 seconds until confirmed by beep of buzzer.
2. Rotate dial to desired run time (hours) or gallons as indicated on the dial.
3. Push start button. Timer will start from zero and when set time is reached, system will stop automatically at the end and alert the user with audio and light indicator.
4. Stop operation: Pressing the stop button during operation will stop the motor and stores the amount of time remaining. Upon starting again, the system starts from the time last reached continues operation to complete the cycles.

To Polish When Dispensing

1. Ensure timer is set to zero and reset timer by pressing the start/stop button for 2 seconds until confirmed by beep of buzzer.
2. Press start button to start motor.
3. Insert nozzle or hose into desired tank/container and begin dispensing. If using standard nozzle, it will not automatically shutoff the pump.

Alarm

See Diagnostic Signal table to identify alarm state. In the event of an alarm condition for water or high vacuum, the timer will stop and hold its memory. Clear the alarm condition:

1. Shutoff alarm: Press start/stop button quickly to switch off both indicator lights and buzzer.
2. Drain water. Push in and turn the yellow knob to open drain valve. If no water is present, move to next step.
3. Backflush the filter. See Filter Backflushing Instructions.
4. Press start button to begin operation again.
5. Observe vacuum gauge. If below -40.5 cm-Hg (-7.83 psi OR 16 in-Hg), it will continue to operate from point of initial alarm.

System State	Light Indicators of Start Button and Audio Signals of Buzzer	
Power Cord Plugged In Unit in standby.	In Use Indicator (green) OFF ----- Alarm Indicator (red) OFF ----- Buzzer OFF ----- Motor OFF -----	
Pump start Press start/stop button • Less than 2 sec - without set time/quantity reset. OR • Longer than 2 sec - with set time/quantity reset. Press start button. Pump starts. State of transfer & filtration.	In Use Indicator (green) ON Alarm Indicator (red) OFF ----- Buzzer OFF ----- Motor ON	
Forced stop of start/stop button Press start button. Press again to stop. Pump stops.	In Use Indicator (green) OFF ----- Alarm Indicator (red) OFF ----- Buzzer OFF ----- Motor OFF -----	
Stop after reaching timer/quantity setting	In Use Indicator (green) FLASH ____ 1 Flash ____ Flash stays on until start/stop button is pressed again. Alarm Indicator (red) OFF ----- Buzzer BEEP (4) ____ ____ ____ Motor OFF -----	
Note: In the subsequent alarm states, (with red alarm flashing) beeps and alarm indicator flashes will continue until the start/stop button is pressed. Quickly press the start/stop button to switch off buzzer and flashing indicators.		
High Water Alarm The motor turns off.	In Use Indicator (green) OFF ----- Alarm Indicator (red) FLASH ____ 1 Flash ____ Stop Buzzer BEEP ____ ____ Motor OFF -----	
High Vacuum The motor switches off and the filter must be serviced.	In Use Indicator (green) OFF ----- Alarm Indicator (red) FLASH ____ 2 Flashes ____ Stop Buzzer BEEP ____ Motor OFF ____	
Standby with max current alarm The current absorbed by the motor exceeds about 10A at 110V or 220V for more than 1 second.	In Use Indicator (green) OFF ----- Alarm Indicator (red) FLASH ____ 3 Flashes ____ Stop Buzzer BEEP ____ Motor OFF ____	
Motor fails to start Triggers if a start signal is given to the motor but the current sensor fails to detect current flow. The cause of this fault could be: <ul style="list-style-type: none"> • Motor thermal cutout has tripped • Wire has become detached in wiring harness supplying the motor • Motor winding failure • Fault in the electronic motor control components 	In Use Indicator (green) OFF ----- Alarm Indicator (red) FLASH ____ 4 Flashes ____ Stop Buzzer BEEP ____ Motor OFF ____	

Note:

Prior to servicing the filters, ensure that the engine is OFF.

Backflushing is for particulate removal only and will not remove sludge once embedded in the filter media.

Step 1

Turn the system off and shut off the fuel supply valve.

Open the bleed screw located at top of filter lid by slightly unscrewing it.

This will break the vacuum in the filter allowing water and small particulates to be released from the element.

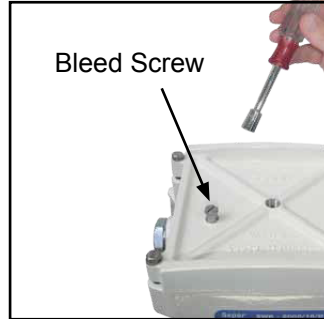

Step 2

Allow water and dirt to settle into bowl.

Large droplets of water and dirt will fall to the bottom of the bowl.



Step 3

PUSH in and turn counter-clockwise to open drain valve.

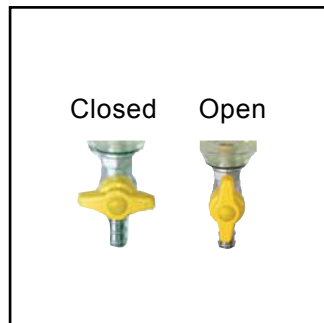

Step 4

Drain out the water and dirt that has accumulated in the bottom of the bowl.



Step 5

Close drain valve by pushing and turning clockwise. Allow dirt and water to settle again.



Step 6

As the fuel is drained out of the separator in step 4, more dirt and water will be flushed from the filter and will collect in the bottom of the bowl. If necessary, repeat steps 4 and 5.

If not, open fuel supply valve.



Step 7

Prime the filter and close the bleed screw.

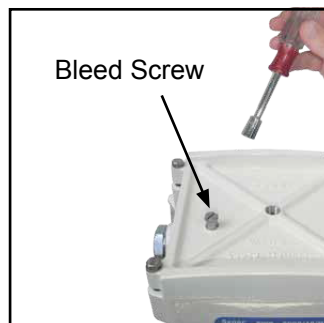

Filter Element Replacement Instructions

Note:

Only use genuine Separ filter elements.

Prior to servicing the filters, ensure that the unit is OFF.

Step 1

Shut off the fuel supply valve and isolate unit before servicing the filter. Locate the lid bolts, which are either wing bolts or hex bolts.

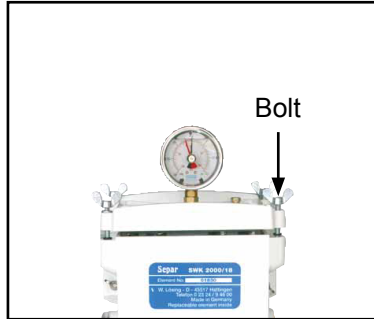

Step 2

Unscrew the lid bolts evenly.



Step 3

Remove the lid with the lid gasket.

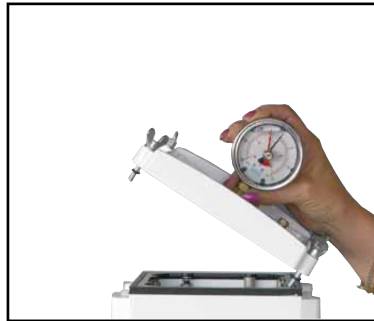

Step 4

Take out the spring frame.

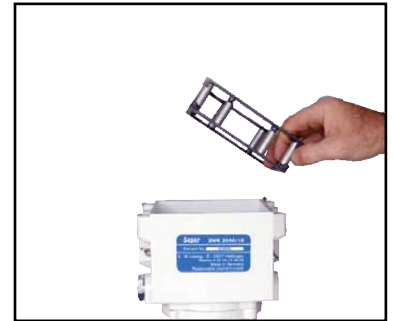

Step 5

Lift out filter element by the handle. Replace with new filter element and re-fit the spring frame.



Step 6

Inspect lid gasket. Replace if necessary.

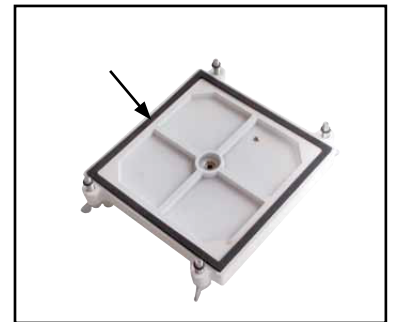

Step 7

Fit lid checking for correct positioning. Evenly tighten in the sequence shown.



Step 8

Open the fuel supply valve, prime fuel system and check for leaks.



Part #	Description	Category
04010	Separ Filter 10 micron element	Filter
04030	Separ Filter 30 micron element	
04060S	Separ Filter 60 micron element, stainless	
66-30440	Lid gasket for SWK-2000/40	
66-30442	Bowl gasket	
66-30980	Seal kit for SWK-2000/40	
16-30404	Lid screw	
64-30567	Bowl screw	
16-30408	Bleed screw	
66-30456	Drain valve	
66-30435-01	Lid for SWK-2000/40	
66-30299	Spring frame	
80-3146	Replacement pump	Pump
80-3770	Vane kit for pump	
80-3771	Drip pan	
80-3277	120V, 60Hz PC board	
80-3276	230V, 50Hz PC board	
80-3275	Momentary push button on control panel	
80-3228	Manual nozzle	
80-3189	Nozzle holder	
80-3192	Flow meter	
80-3273	Strainer valve (suction side)	

A BECOMING ACQUAINTED WITH K24

Electronic digital meter featuring a turbine measurement system, designed for precise measuring of low viscosity fluids. It is divided into two using macrogroups:

- 1 With body made of inconductive plastic material of light colour, designed to be used with water / urea solution
- 2 With body made of conductive plastic material of dark colour (assessed resistance: 50 ohm), designed to be used with DIESEL FUEL, WATER and windscreen fluids.

The card can be rotated with respect to its housing, thus allowing easy display readings in any position. The card housing, easily accessible, is closed by a plastic cover sealed through a rubber protection acting as a gasket as well. The whole unit can be easily removed by unscrewing the 4 screws fixing the card and the cover.

A1 Measurement System

Turbine measurement system. The turbine is placed inside a hole through the body of k24, fitted with threaded inlet and outlet. The body of k24 is made of a plastic material that allows several types of threads with relevant combinations. K24 has 2 rubber protections, designed to act as gaskets, too, and thus reducing the number of its components.

The liquids compatible with k24 must be at low viscosity, namely:

- Diesel fuel
- Water
- Water/urea solution
- Kerosene
- Windscreen
- Petrol

Main components:

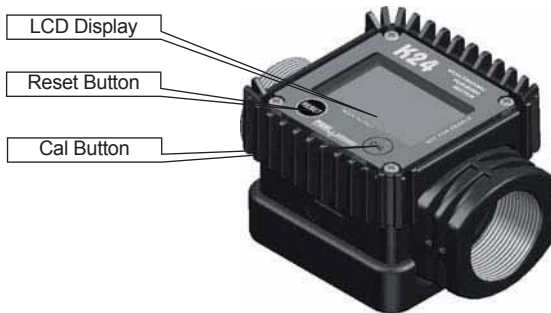

A2 Display Positioning

The square shape of the k24 body allows the card to be rotated in its housing, thus ensuring great versatility in positioning.

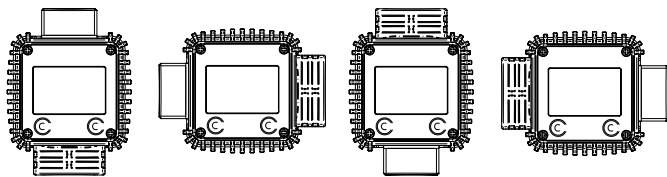

! ATTENTION
While fixing the K24 card, make sure the battery contact cable is not placed above the circular housing of the bulb.

A3 Operating modes

The user can choose between two different operating modes:
- Normal Mode: Mode with display of Partial and Total dispensed quantities.
- Flow Rate Mode: Mode with display of Flow Rate, as well as Partial dispensed quantity.

The meter features a non-volatile memory for storing the dispensing data, even in the event of a complete power break for long periods. The measurement electronics and the LCD display are fitted in the top part of the K24 which remains isolated from the fluid-bath measurement chamber and sealed from the outside by means of a cover.

A4 LCD display

The "LCD" of the METER features two numerical registers and various indications displayed to the user only when the applicable function so requires.

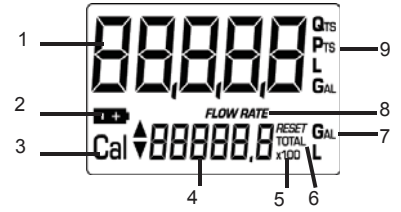

Key:

1. Partial register (5 figures with moving comma FROM 0.1 to 99999) indicating the volume dispensed since the reset button was last pressed;
2. Indication of battery charge;
3. Indication of calibration mode;
4. Totals register (6 figures with moving comma FROM 0.1 to 999999), that can indicate two types of Total:
 - 4.1. General Total that cannot be reset (TOTAL)
 - 4.2. Resettable total (Reset TOTAL)
5. Indication of total multiplication factor (x10 / x100)
6. Indication of type of total, (TOTAL / Reset TOTAL);
7. Indication of unit of measurement of Totals: L=Litres Gal=Gallons
8. Indication of Flow Rate mode
9. Indication of unit of measurement of Partial: Qts=Quarts Pts=Pints L=Litres Gal=Gallons

A5 User Buttons

The k24 features two buttons (reset and cal) which individually perform two main functions and, together, other secondary functions.

The main functions performed are:

- For the reset key, resetting the partial register and resettable total (reset total)
- For the cal key, entering instrument calibration mode.

Used together, the two keys permit entering configuration mode, useful for changing the units of measurements and calibration factor.

A6 Battery Housing

The k24 is powered by two standard type 1.5 V batteries (size AAA).

The battery housing, easily accessible, is closed by a metal cover sealed through a rubber protection acting as a gasket as well. The whole unit can be easily removed by unscrewing the 4 screws fixing the cover and the protection to the body.

B INSTALLATION

K24 features a threaded, perpendicular inlet and outlet (1" gas or ntp male and female that can be combined together). It has been designed to be easily installed in any position: fixed in-line or mobile on a dispensing nozzle.

In order to improve the life of the turbine, it is recommended to fit a strainer before the meter itself

! ATTENTION
At the female inlets, tighten the couplings at a max. torque of 55N/m.

! ATTENTION:
WITH THE GAS-FEMALE INLETS, DO NOT USE CONICAL THREADED COUPLINGS.

C DAILY USE

The only operations that need to be done for daily use are partial and/or resettable total register resetting.

The user should use only the dispensing system of k24. Occasionally the meter may need to be configured or calibrated. To do so, please refer to the relevant chapters.

Below are the two typical normal operation displays. One display page shows the partial and reset total registers. The other shows the partial and general total. Switchover from resettable total to general total display is automatic and tied to phases and times that are in factory set and cannot be changed.

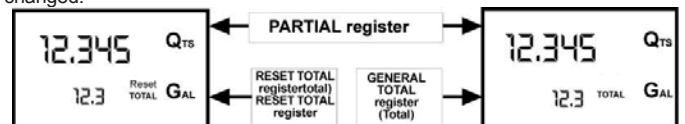

NOTE: 6 digits are available for Totals, plus two icons x 10 / x100. The increment sequence is the following:
0.0 → 99999.9 → 999999 → 100000 x 10 → 999999 x 10 → 100000 x 100 → 999999 x 100

C1 Dispensing in Normal mode

Normal mode is the standard dispensing. While the count is made, the partial and resettable total are displayed at the same time (reset total).

Should one of the keys be accidentally pressed during dispensing, this will have no effect.

A few seconds after dispensing has ended, on the lower register, the display switches from resettable total to general total: the word reset above the word total disappears, and the reset total is replaced by the general total.

This situation is called standby and remains stable until the user operates the k24 again.

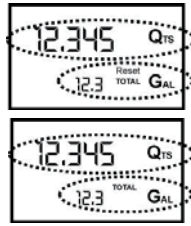

C1.1 Partial reset

The partial register can be reset by pressing the reset key when the meter is in standby, meaning when the display screen shows the word "TOTAL".

After pressing the reset key, during reset, the display screen first of all shows all the lit-up digits and then all the digits that are not lit up.

At the end of the process, a display page is first of all shown with the reset partial and the reset total

and, after a few moments, the reset total is replaced by the non resettable Total.

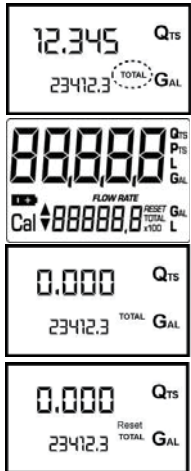

C1.2 Resetting the Reset Total

The reset total resetting operation can only be performed after resetting the partial register. The reset total can in fact be reset by pressing the reset key at length while the display screen shows reset total as on the following display page:

Schematically, the steps to be taken are:

1. Wait for the display to show normal standby display page (with total only displayed),
2. Press the reset key quickly
3. The meter starts to reset the partial
4. While the display page showing the reset total is displayed Press the reset key again for at least 1 second
5. The display screen again shows all the segments of the display followed by all the switched-off segments and finally shows the display page where the reset Reset Total is shown.

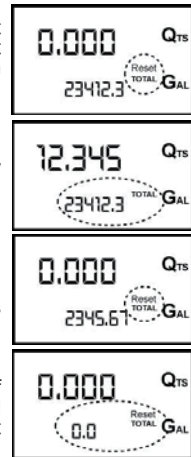

C.2 Dispensing with Flow Rate Mode display

It is possible to dispense fluids, displaying at the same time:

- * the dispensed partial
- * the Flow Rate in [Partial Unit / minute] as shown on the following display page:



Procedure for entering this mode:

- wait for the Remote Display to go to Standby, meaning the display screen shows Total only
- quickly press the CAL key.
- Start dispensing

The flow rate is updated every 0.7 seconds. Consequently, the display could be relatively unstable at lower flow rates. The higher the flow rate, the more stable the displayed value.

IMPORTANT
The flow rate is measured with reference to the unit of measurement of the Partial. For this reason, in case of the unit of measurement of the Partial and Total being different, as in the example shown below, it should be remembered that the indicated flow rate relates to the unit of measurement



of the partial. In the example shown, the flow rate is expressed in Qts/min. The word "Gal" remaining alongside the flow rate refers to the register of the Totals (Reset or NON Reset) which are again displayed when exiting from the flow rate reading mode.

To return to "Normal" mode, press the CAL key again. If one of the two keys RESET or CAL is accidentally pressed during the count, this will have no effect.

IMPORTANT
Even though in this mode they are not displayed, both the Reset Total and the General Total (Total) increase. Their value can be checked after dispensing has terminated, returning to "Normal" mode, by quickly pressing CAL.

C.2.1 Partial reset

To reset the Partial Register, finish dispensing and wait for the Remote Display to show a Flow Rate of 0.0 as indicated in the illustration then quickly press RESET



D CALIBRATION

D1 Definitions

Calibration factor or "k factor":

Multiplication factor applied by the system to the electrical pulses received, to transform these into measured fluid units.

FACTORY K FACTOR:

Factory-set default factor. It is equal to 1,000. This calibration factor ensures utmost precision in the following operating conditions:

Fluid	diesel fuel
Temperature:	20°C
Flow rate:	10-120 litres/min

Even after any changes have been made by the user, the factory k factor can be restored by means of a simple procedure.

USER K FACTOR:

Customized calibration factor, meaning modified by calibration.

D2 Why Calibrate

When operating close to extreme conditions, such as for instance with fluids close to acceptable range extremes (like diesel fuel at low temperatures) or in extreme flow rate conditions (close to minimum or maximum acceptable values), an on-site calibration may be required to suit the real conditions in which the k24 is required to operate.

D3 Calibration procedure:

K24 permits making quick and precise electronic calibration by changing the calibration factor (k factor).

There are 2 different ways of calibration:

1. On-site calibration, performed by means of a dispensing operation.
2. Direct calibration, performed by directly changing the k factor.

To enter the calibration phases it is necessary to press and hold down the "cal" button.

Why enter the calibration phases?

- Display the currently used calibration factor
- Return to factory k factor after a previous calibration with user k factor
- Change the calibration factor using one of the two previously indicated procedures.

In calibration mode, the partial and total dispensed quantities indicated on the display screen take on different meanings according to the calibration procedure phase. During the calibration, the k24 cannot perform any normal dispensing operations. In calibration mode, the totals are not increased.

! WARNING
The k24 features a non-volatile memory. It keeps the calibration and dispensing data stored even after replacing new batteries or long periods of inactivity.

D3.1 Display Of Current "K Factor" And Restoring "Factory K Factor"

By pressing the cal key while the appliance is in standby, the display page appears showing the current calibration factor used.



If you are using k24 with "factory k factor", the display page shown in the diagram will be displayed, with the word "fact".



If one "user k factor" has been set, the calibration factor set by the user (in our example 0.998) will be displayed. The word "user" indicates a calibration factor set by the user is being used.

The flow chart alongside shows the switchover logic from one display page to another. In this condition, the Reset key permits switching from User factor to Factory factor.

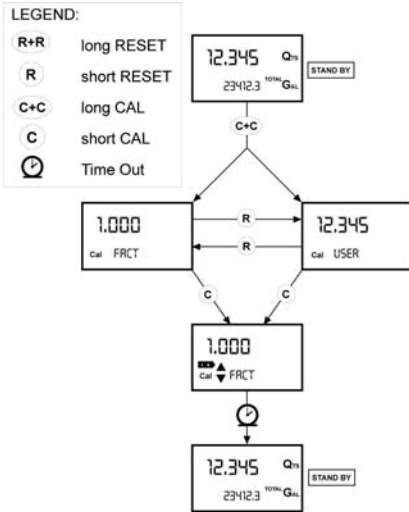

To confirm the choice of calibration factor, quickly press CAL while "User" or "Fact" are displayed.

After the restart cycle, the meter uses the calibration factor that has just been confirmed.

! ATTENTION
When the Factory Factor is confirmed, the old User factor is deleted from the memory

D3.2 In-field Calibration

This procedure calls for the fluid to be dispensed into a graduated sample container in real operating conditions (flow rate, viscosity, etc.) requiring maximum precision.

! WARNING
For correct K24 calibration, it is most important to:

- completely eliminate air from the system before calibrating;
- use a precise Sample Container with a capacity of not less than 5 litres, featuring an accurate graduated indicator.
- ensure calibration dispensing is done at a constant flow rate equivalent to that of normal use, until the container is full;
- not reduce the flow rate to reach the graduated area of the container during the normal dispensing stage (the correct method during the normal stages of sample container filling consists in making short top-ups at normal operation flow rate);
- after dispensing, wait a few minutes to make sure any air bubbles are eliminated from the sample container; only read the Real value at the end of this stage, during which the level in the container could drop.
- if necessary, carefully follow the procedure indicated below.

D3.2.1 In-field calibration procedure:

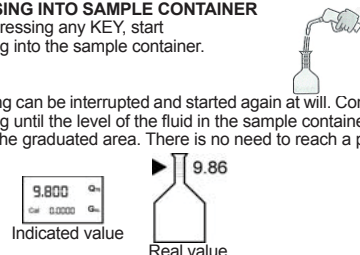
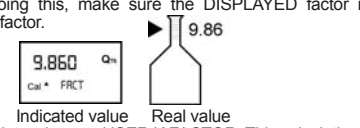
AZIONE	DISPLAY
1 NONE K24 IN STAND BY	12.345 Qrs 12.5 TOTAL Gals
2 LONG CAL KEY KEYING K24 enters calibration mode, shows "CAL" and displays the calibration factor in use instead of total. The words "Fact" and "USER" indicate which of the two factors is currently in use.	1.000 Qrs Cal FACT Gals
3 LONG RESET KEY KEYING K24 shows "CAL" and the partial at zero. K24 is ready to perform on-site calibration.	0.000 Qrs Cal FIELD
4 DISPENSING INTO SAMPLE CONTAINER Without pressing any KEY, start dispensing into the sample container. Dispensing can be interrupted and started again at will. Continue dispensing until the level of the fluid in the sample container has reached the graduated area. There is no need to reach a preset quantity. 	9.800 Qrs Cal FIELD
5 SHORT RESET KEY KEYING K24 is informed that the calibration dispensing operation is finished. Make sure dispensing is correctly finished before performing this operation. To calibrate the K24, the value indicated by the partial totaliser (example 9.800) must be forced to the real value marked on the graduated sample container. In the bottom left part of the display an arrow appears (upwards and downwards), THAT SHOWS the direction (increase or decrease) of the USER K FACTOR value change when the operations 6 or 7 are performed	9.800 Qrs Cal ▲ FIELD
6 SHORT RESET KEY KEYING Arrow direction changes. The operation can be repeated IF NECESSARY	9.800 Qrs Cal ▼ FIELD
7 SHORT/LONG CAL KEY KEYING The indicated value changes in the direction indicated by the arrow - one unit for every short CAL key keying - continually if the CAL key is kept pressed. (for the first 5 units slowly and then quickly). If the desired value is exceeded, repeat the operations from point (6).	9.860 Qrs Cal ▲ FIELD
8 LONG RESET KEY KEYING K24 is informed that the calibration procedure is finished. Before doing this, make sure the DISPLAYED factor is the ACTUAL factor. 	--- Qrs Cal END
9 NO OPERATION At the end of the calculation, the new USER K FACTOR is shown for a few seconds, after which the restart cycle is repeated to finally achieve standby condition. ATTENTION: From now on, the indicated factor will become the calibration factor used by the meter and will continue to remain such even after a battery change	1.015 Qrs Cal END
10 NO OPERATION K24 stores the new calibration factor and is ready for dispensing, applying the newly defined USER K FACTOR.	0.000 Qrs Cal 1234.5 TOTAL Gals

D3.3 Direct modification of K factor

This procedure is especially useful to correct a "mean error" obtainable on the basis of several performed dispensing operations. If normal K24 operation shows a mean percentage error, this can be corrected by applying to the currently used calibration factor a correction of the same percentage. In this case, the percentage correction of the USER K FACTOR must be calculated by the operator in the following way:

$$\text{New K Factor} = \text{Old K Factor} * \left(\frac{100 - E\%}{100} \right)$$

Example:
Error percentage found E% - 0.9 %
CURRENT calibration factor 1,000
New USER K FACTOR $1,000 * [(100 - (-0.9))/100] = 1,000 * [(100 + 0.9)/100] = 1.009$

If the meter indicates less than the real dispensed value (negative error) the new calibration factor must be higher than the old one as shown in the example. The opposite applies if the meter shows more than the real dispensed value (positive error).

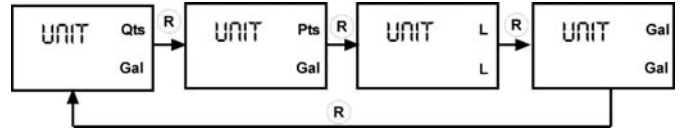

! WARNING
The Resettable Total and Total registers will be automatically changed to the new unit of measurement. NO new calibration is required after changing the Unit of Measurement.

OPERATION	DISPLAY
1 NONE K24 in STAND BY: not in counting mode.	12.345 Qts 1234.5 TOTAL Gal
2 LONG CAL KEY KEYING K24 enters calibration mode, shows "CAL" and displays the calibration factor being used instead of the partial. The words "Fact" and "USER" indicate which of the two factors (factory or user) is currently being used.	1.000 Cal FRACT (USER)
3 LONG RESET KEY KEYING K24 shows "CAL" and the partial at zero. K24 is ready to perform on-site calibration by dispensing.	12.345 Qts Cal FIELD
4 LONG RESET KEY KEYING We now go on to Direct change of the calibration factor: the word "Direct" appears together with the Currently Used calibration factor. In the bottom left part of the display, an arrow appears (upwards or downwards) defining the direction (increase or decrease) of change of the displayed value when subsequent operations 5 or 6 are performed.	1.000 Qts Cal ▲ DIRECT
5 SHORT RESET KEY KEYING Arrow direction changes. The operation can be repeated to alternate the direction of the arrow.	1.000 Cal ▼ DIRECT
6 SHORT/LONG CAL KEY KEYING The indicated value changes in the direction indicated by the arrow - one unit for every short CAL key keying - continually if the CAL key is kept pressed. The speed increase rises by keeping the key pressed. If the desired value is exceeded, repeat the operations from point (5).	1.003 Qts Cal ▲ DIRECT
7 LONG RESET KEY KEYING K24 is informed that the calibration procedure is finished. Before performing this operation, make sure the indicated value is that required.	----- Qts Cal ▲ DIRECT
8 NO OPERATION At the end of the calculation, the new USER K FACTOR is shown for a few seconds, after which the restart cycle is repeated to finally achieve standby condition. ATTENTION: From now on, the indicated factor will become the calibration factor used by the meter and will continue to remain such even after a battery change.	1.003 Qts Cal END
9 NO OPERATION The K24 stores the new work calibration factor and is ready to begin dispensing, using the USER K FACTOR that has just been calculated.	0.000 Qts 13456 TOTAL Gal

F MAINTENANCE

K24 has been designed to require a minimum amount of maintenance.

The only types of maintenance required are the following:

1. Battery change – necessary when the batteries have run down
2. Cleaning of the turbine with washing or mechanically-handling

1 Battery Replacement

K24 is complete with 2 x 1.5 V. alkaline batteries SIZE AAA. K24 features two low-battery alarm levels:

1) When the battery charge falls below the first level on the LCD, the fixed battery symbol appears.



In this condition, K24 continues to operate correctly, but the fixed icon warns the user that it is ADVISABLE to change the batteries.

2) If K24 operation continues without changing the batteries, the second battery alarm level will be reached which will prevent operation. In this condition the battery icon starts to flash and is the only one to remain visible on the LCD.

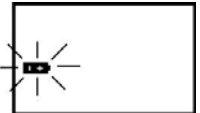

! WARNING
Do not discard the old batteries in the environment. Refer to local disposal regulations.

To change the batteries, with reference to the exploded diagram positions, proceed as follows:

- Press RESET to update all the totals
- Loosen the 4 fixing screws of the lower cover
- Remove the old batteries
- Place the new batteries in the same position as the old ones
- close the cover again, by positioning the rubber protection as a gasket
- K24 will switch on automatically and normal operation can be resumed.

The K24 will display the same Reset Total, the same Total and the same Partial indicated before the batteries were changed. After changing the batteries, the meter does not need calibrating again.

2. Cleaning

Only one operation is necessary to clean the k24. After removing k24 from the plant where it was built in, any residual elements can be removed by washing or mechanically-handling. If this operation does not restore a smooth rotation of the turbine, it will have to be replaced.

! WARNING:
Do not use compressed air onto the turbine in order to avoid its damage because of an excessive rotation

E METERS CONFIGURATION

Some models of meter feature a menu with which the user can select the main measurement unit, Quarts (Qts), Pints (Pts), Litres (Lit), Gallons (Gal); The combination of the unit of measurement of the Partial register and that of the Totals is predefined according to the following table:

Combination no.	Unit of Measurement of the Partial Register	Register Unit of Measurement of the Totals Register
1	Litres (L)	Litres (L)
2	Gallons (Gal)	Gallons (Gal)
3	Quarts (Qts)	Gallons (Gal)
4	Pints (Pts)	Gallons (Gal)

To choose between the 4 available combinations:

- wait for K24 to go to Standby,
- press the CAL and RESET keys together. Keep these pressed until the word "UNIT" appears on the screen together with the unit of measurement set at that time (in this example Litres / Litres)
- Press the reset key to select the desired combination of unit of measurement, amongst those shown below.
- Save the new combination by pressing the cal key at length. K24 will pass through the start cycle and will then be ready to dispense in the set units.

Problem	Possible Cause	Corrective Action
Motor is not turning	Lack of electric power	Check the electrical connections and the safety systems
	Rotor jammed	Check for possible damage or obstruction of the rotating components
	Motor Problems	Contact the service department
Motor turns slowly when starting	Low voltage in the electric power line	Bring the voltage back within the anticipated limit
Low or no flow rate	Low level in the suction tank	Refill the tank
	Foot valve blocked	Clean the filter
	Excessive suction pressure	Lower the pump with the respect to the level of the tank or increase the cross-section of the piping
	High loss of head in the delivery circuit (working with the bypass open)	Use shorter piping or of greater diameter
	Bypass valve blocked	Dismantle the valve, clean and/or replace it
	Air entering the pump or the suction piping	Check the seals of the connections
	Narrowing in the suction piping	Use piping suitable for working under suction pressure
	Low rotation speed	Check the voltage at the pump. Adjust the voltage and/or use cables of greater cross-section
	Suction piping is resting on the bottom of the tank	Raise the piping
Increased pump noise	Cavitation occurring	Reduce suction pressure
	Irregular functioning of the bypass	Dispense until the air is purged from the bypass system
	Presence of air in the fluid	Wait for the oil in the tank to settle
Leakage from the pump body	Seal damaged	Check and replace the seal
Reduced filtering standard	Full filters	Empty and clean filters